



AC FUNCTION MODULE DATA GUIDE

DESCRIPTION

The AC Function Module is a member of the Linx pre-certified OEM product line. The module plugs directly into a wall receptacle and is capable of switching devices at loads of up to 1,800 watts (15 amps) or 1HP at up to 120VAC. Devices under control connect via a standard NEMA 5-15 North American power plug. The AC Function module is UL listed and has been tested for FCC and Industry Canada compliance. Front and rear graphics can be quickly customized for a truly unique product appearance. This greatly reduces the time and expense of bringing a wireless product to market. The AC Function Module is durably constructed using high quality components. When paired with a compatible Holtek-based Linx Handheld transmitter or a Linx transmitter module, the AC Function Module provides reliable wireless switching over distances of up to 500 feet.

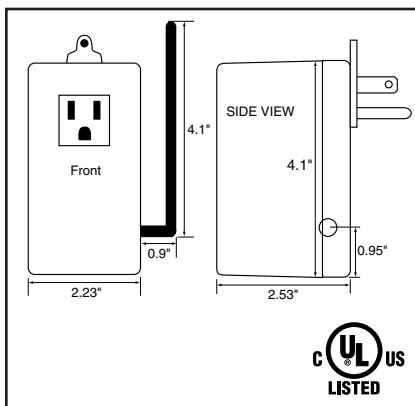

Figure 1: Package Dimensions

FEATURES

- Heavy duty construction
- Switch 1,800 watts at 15 amps
- UL Listed
- FCC pre-tested
- 16 unique addresses
- Selectable group capabilities
- Standard NEMA 5-15 power plug
- Easy cosmetic customization
- Ideal for OEM applications



OEM Configurations

With a one-time NRE and minimum order, Linx can configure the label areas to meet your specific requirements. Contact Linx for details.

APPLICATIONS INCLUDE

- General Remote Control
- Process Control
- Lighting Control
- Home / Industrial Automation
- Wire Elimination

ORDERING INFORMATION

PART #	DESCRIPTION
FCTN-WALL-315	AC Function Module - 315MHz
FCTN-WALL-418	AC Function Module - 418MHz
FCTN-WALL-433	AC Function Module - 433MHz

ELECTRICAL SPECIFICATIONS

Parameter	Designation	Min.	Typical	Max.	Units	Notes
POWER SECTION						
Operating Voltage	V _{CC}	-	110	120	VAC	-
Relay Rating	-	100	-	-	mA	2
Tungsten or Resistive load	-	-	-	15.0	A	1
Electronic Ballast	-	-	-	5.0	A	1
Power	-	-	-	1,800	W	1
Power	-	-	-	1	HP	1
Power	-	-	-	15	FLA	1
Relay Cycle Life	-	-	1x10 ⁵	-	-	-
RECEIVER SECTION						
Receive Frequency Range:	F _C	-	-	-	-	-
FCTN-WALL-315	-	-	315	-	MHz	-
FCTN-WALL-418	-	-	418	-	MHz	-
FCTN-WALL-433	-	-	433.92	-	MHz	-
Center Frequency Accuracy	-	-50	-	+50	kHz	-
Receiver Sensitivity	-	-106	-112	-118	dBm	-
Noise Bandwidth	N _{3dB}	-	280	-	kHz	1
ENVIRONMENTAL						
Operating Temperature Range	-	-30	-	+50	°C	1
Storage Temperature Range	-	-45	-	+85	°C	1

Table 1: FCTN-WALL-*** Specifications

Notes

1. Characterized, but not tested.
2. Minimum relay load of any approved type

AC FUNCTION MODULE FEATURES

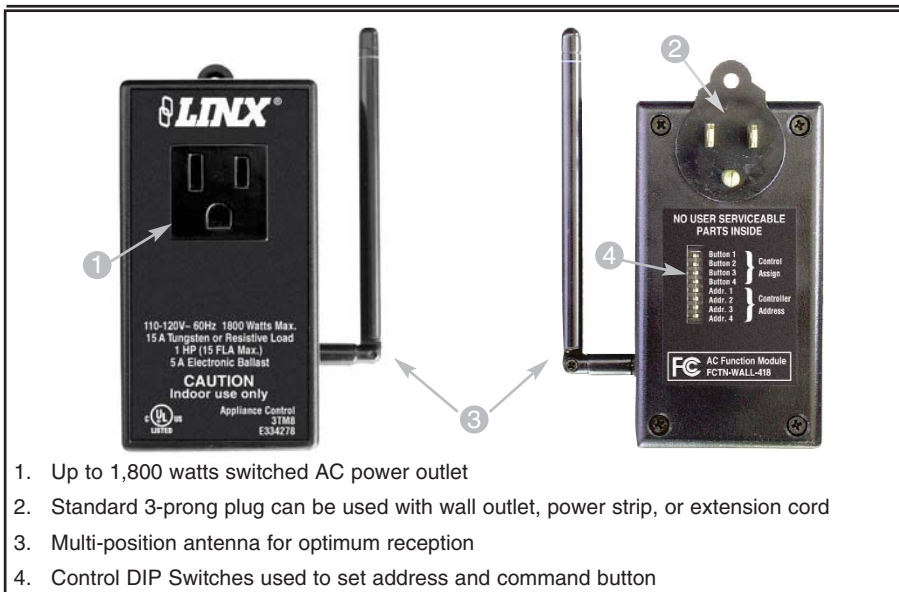

Figure 2: FCTN-WALL-*** Features

THEORY OF OPERATION

The FCTN-WALL-*** module combines the popular Linx LR Series receiver with a decoder and high quality switching relay. When transmitted data is received, the data is presented to the decoder. The decoder detects the logic states of the DIP switch address lines, and if these match the address settings of the encoder, the decoder's outputs are set to replicate the state of the encoder's inputs. In the AC Function Module, the data lines are also compared to the settings of four control dip switches that determine which transmitter buttons or data lines will be accepted. The relationship is shown in the adjacent chart. If the DIP switch labeled Button 1 is turned on, then when data line D6 on the decoder goes high, the AC Function Module will activate and apply power to the output. When line D7 goes high, the module will turn off. As long as the other button switches are turned off, the module will ignore all of the other data lines. If multiple DIP switches are turned on, then the module will be controlled by multiple buttons or data lines. For example, if switches 1 and 2 are on, then lines D6 and D4 will switch the AC Function Modules output on and lines D7 and D5 will turn it off.

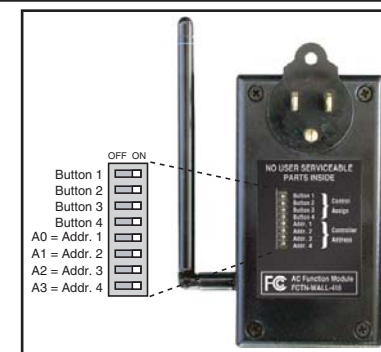

Figure 3: Module DIP Switches

DIP Switch	Data Lines		
	Button	Off	On
1		D7	D6
2		D5	D4
3		D3	D2
4		D1	D0

SETTING MODULE ADDRESS

The AC Function Module provides a total of sixteen unique address settings. Address selection is made via the bottom four DIP switches on the module. In order for the encoded commands sent by the transmitter to be recognized, the address settings of the transmitter and receiver must match exactly.

CREATING UNIQUE GROUPS

The four control DIP switches can be used to create distinct groups of AC Function Modules that can all be operated by a single command unit. For example, any number of AC Function Modules can be set to a single address and be controlled by one of the button pairs (ON / OFF) on a command unit. You can also set up different banks using up to sixteen AC Function Modules, each set to a different address. Please read the Contention Considerations section when using multiple transmitters in close proximity.

EQUIPMENT CONNECTION

Each AC Function Module is designed to switch AC loads of up to 1,800 watts. Plug the AC Function Module in, then plug the equipment to be switched into the receptacle on the face of the unit. More than one device can be connected with the addition of a power strip; however, the total draw of all connected equipment must never exceed the unit's 1,800W rating.

FUSE REPLACEMENT

An internal fuse protects the AC Function Module if the output is shorted or an excessive load is attached. Following such an event, the fuse can be replaced by unplugging the unit, removing the 4 rear screws, folding the cover over (DO NOT UNPLUG THE WIRES GOING TO THE COVER RECEPTACLE), and unclipping the fuse. The location of the fuse is shown in Figure 4. Replace only with an approved type and rating of fuse (See UL Compliance section). Never use a different value or attempt to bypass the fuse, as extensive damage to the module, equipment, or property may result. If the fuse blows immediately after replacement, service may be required.

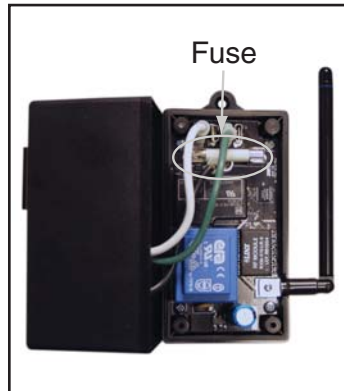

Figure 4: FCTN-WALL-418 Fuse

ANTENNA ORIENTATION

It is always important to remember that the control signals for the AC Function Module are sent through the air. For this reason, the physical orientation of the transmitter and receiver plays an important role in determining the overall range. The antenna may be swiveled to adjust for maximum range in your environment. In most cases, orienting the antenna in a vertical position will result in optimum performance.

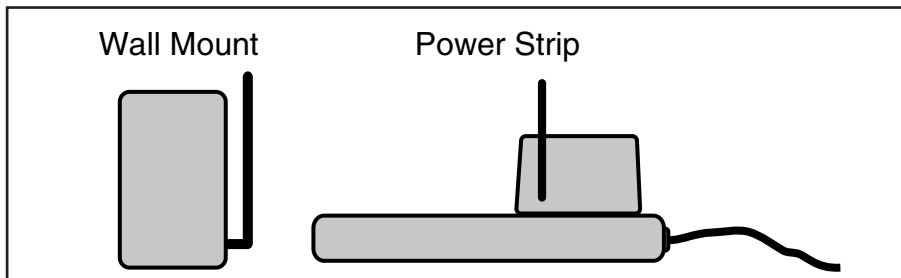

Figure 5: FCTN-WALL-*** Antenna Orientation

CONTENTION CONSIDERATIONS

When working in a wireless environment it is always important to distinguish between uniqueness and contention. The address lines provided on OEM modules allow for the uniqueness of system components, however, this does not eliminate contention between transmitted signals in free space. For this reason only one transmitter at a time can be active on the same frequency within a reception area without creating interference. If two or more transmitters are activated at the same time, the AC Function Module will receive a corrupted signal and take no action. An unlimited number of AC Function Modules may be successfully operated in proximity without interference since they contain a receiver rather than a transmitter.

INTERFERENCE CONSIDERATIONS

The range performance of the modules is heavily dependent on the environment in which they are operated. The effects of interference, multipath, and physical attenuation will vary significantly from location to location.

The AC Function Module is based on the Linx LR Series RF receiver. It utilizes OOK AM-based modulation. AM devices can be affected by external noise, such as that from motors or other sources of broadband RF emissions. Interference can also come from sources such as paging towers or amateur radio activity. The designer should carefully test the AC Function Module in the environment in which it will be used to ensure that its performance is appropriate for the chosen application.

TRANSMITTER CONSIDERATIONS

The AC Function Module incorporates a Linx LR Series receiver. There are several options available for controlling the module.

The first option is to use one of the pre-certified OEM transmitters offered by Linx. These transmitters come in several packages and can be customized to bear the logo or other artwork required by the customer. The only setup required by the customer is to set the address of the transmitter and the AC Function Module.

There are four OEM transmitters that can be used with the AC Function Module: the Full-Size Handheld, the Compact Handheld, the Long-Range Handheld, and the Keyfob. The Full-Size Handheld uses eight address lines while the AC Function Module uses four. This means that the last four address lines (A4 through A7) on the Full-Size Handheld should be turned off.



Figure 6: Pre-Certified Transmitters

The other three transmitters use all ten address lines offered by the Holtek ICs, while the AC Function Module uses four. This means that the last six address lines (A4 through A9) on the transmitters must be left floating (turn off the DIP switches on the handhelds, cut traces 4 through 9 on the Keyfob). The other address lines can be set to whatever the user desires, as long as the transmitter and the AC Function Module match.

A custom transmitter can also be created with a KH2 Series transmitter or an LC or LR Series transmitter paired with a Holtek encoder or microprocessor. Because these devices offer all ten address lines used by the Holtek ICs, the last six lines (A4 through A9) must be left open. The Holtek address lines are tri-state, meaning that they have three valid input conditions: high, low, or floating. The AC Function Module uses only the low and floating states, so the custom transmitter can only use these states as well. The lines that are floating should be left open and have no electrical connection.

SAFETY AND COMPLIANCE

The AC Function Module has been designed and tested to meet certain safety and compliance standards. Please read, understand, and follow all safety and compliance messages within this guide and check to ensure that the standards to which the product has been tested are appropriate for your intended use.

UNDERWRITERS LABORATORIES (UL)

The AC Function Module has been tested by Underwriters Laboratories (UL®) for compliance with the following standards:

UL 244A UL 916 CSA C22.2 #24-93

The AC Function Module is UL® listed for indoor operation only as a solid-state appliance control. Operation in environments or applications other than those associated with the above is not recommended.

The use of the UL® mark is protected, and may be used only by the original licensee. Linx offers a full customization program for our valued OEM partners that is designed to maintain compliance with use of the UL® mark. The UL® mark may not be placed on labels or graphics for this product not originating from Linx.

End user manuals for the AC Function Module should indicate that no user serviceable parts are contained inside the unit. The end user manual **should not** contain replacement fuse information or other internal diagrams. A service manual, however, may contain complete fuse information, and should be accompanied by the following statement:

WARNING: To reduce the risk of electrical shock, replace only with the same type and rating of fuse.

A service manual may reference the following approved replacement fuses only:

- Littelfuse p/n 326025, 25A, 125V, slow blow
- Schurter p/n 7043.8230, 20A, 250V, time lag
- Cooper Bussman p/n MDA-20-R, 20A, 250VAC, time delay
- Littelfuse p/n 314025, 25A, 250 V, Fast Acting

COMPLIANCE REQUIREMENTS

The AC Function Module has been tested by an FCC-approved facility and been found to comply with all applicable FCC and Industry Canada requirements as of the date of this document. A Declaration of Conformity (DoC) is on file. It is the user's responsibility to determine if any additional regulatory or safety testing will be required on the user's completed product. In products where no additional testing is required, no further labeling of the unit is needed unless the module will be placed inside another housing. It is, however, necessary to include the following statement in the end product's instruction manual or insert card.

This equipment has been tested and found to comply with the limits for a Class B digital device, pursuant to Part 15 of the FCC Rules. These limits are designed to provide reasonable protection against harmful interference in a residential installation. This equipment generates, uses and can radiate radio frequency energy and, if not installed and used in accordance with the instructions, may cause harmful interference to radio communications. However, there is no guarantee that interference will not occur in a particular installation. If this equipment does cause harmful interference to radio or television reception, which can be determined by turning the equipment off and on, the user is encouraged to try to correct the interference by one or more of the following measures:

- Reorient or relocate the receiving antenna.
- Increase the separation between the equipment and receiver.
- Connect the equipment into an outlet on a circuit different from that to which the receiver is connected.
- Consult the dealer or an experienced radio/TV technician for help.

In order to maintain compliance with FCC regulations, shielded cables must be used with this equipment. Operation with non-approved equipment or unshielded cables is likely to result in interference to radio and TV reception. The user is cautioned that changes and modifications made to the equipment without the approval of manufacturer could void the user's authority to operate this equipment.

Place the above statement in the instruction manual or insert card.

LABELING REQUIREMENTS

In cases where the FCTN-WALL-*** module is incorporated inside a product and its standard labeling is not visible, the end product must be labeled as shown.



*** = frequency

- The label shall not be a stick-on paper label. The label shall be "permanently affixed" to the device (meaning the label is etched, engraved, stamped, silk-screened, indelibly printed on a permanently attached part of the device, or on a nameplate fastened to the equipment by welding, riveting, or a permanent adhesive). The label must be designed to last the expected lifetime of the equipment in the environment in which the equipment may be operated and may not be readily detachable.
- When the device is constructed in two or more sections connected by wires and marketed together, the label is required to be affixed only to the main control unit.

TRANSMITTER ADDRESS SETTINGS

The AC Function Module and the corresponding transmitter must have the same address setting in order to function together. The following figures show how to set the address on the Linx transmitters described in the previous section. Application Note AN-00300 describes setting the addresses on the OEM products in detail. This note can be downloaded from the Linx website, www.linxtechnologies.com.

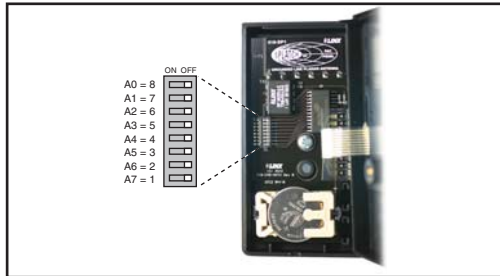

Figure 7: Full-Size Handheld Transmitter

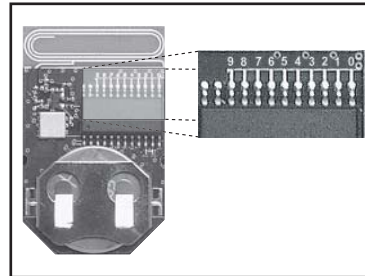

Figure 8: Keyfob Transmitter

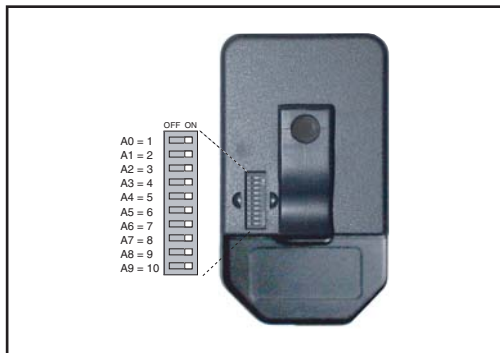

Figure 9: Compact Handheld Transmitter



Figure 10: Long Range Handheld Transmitter

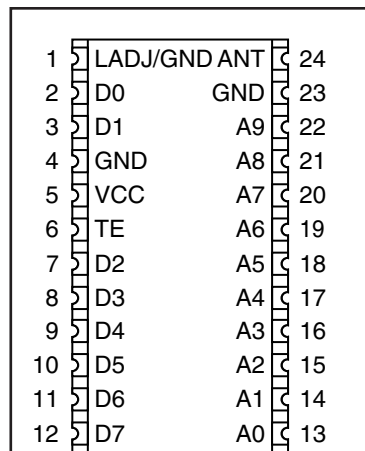

Figure 11: KH2 Series Transmitter

ONLINE RESOURCES



www.linxtechnologies.com

- Latest News
- Data Guides
- Application Notes
- Knowledgebase
- Software Updates



If you have questions regarding any Linx product and have Internet access, make www.linxtechnologies.com your first stop. Our website is organized in an intuitive format to immediately give you the answers you need. Day or night, the Linx website gives you instant access to the latest information regarding the products and services of Linx. It's all here: manual and software updates, application notes, a comprehensive knowledgebase, FCC information, and much more. Be sure to visit often!



www.antennafactor.com

The Antenna Factor division of Linx offers a diverse array of antenna styles, many of which are optimized for use with our RF modules. From innovative embeddable antennas to low-cost whips, domes to Yagis, and even GPS, Antenna Factor likely has an antenna for you, or can design one to meet your requirements.



www.connectorcity.com

Through its Connector City division, Linx offers a wide selection of high-quality RF connectors, including FCC-compliant types such as RP-SMAs that are an ideal match for our modules and antennas. Connector City focuses on high-volume OEM requirements, which allows standard and custom RF connectors to be offered at a remarkably low cost.



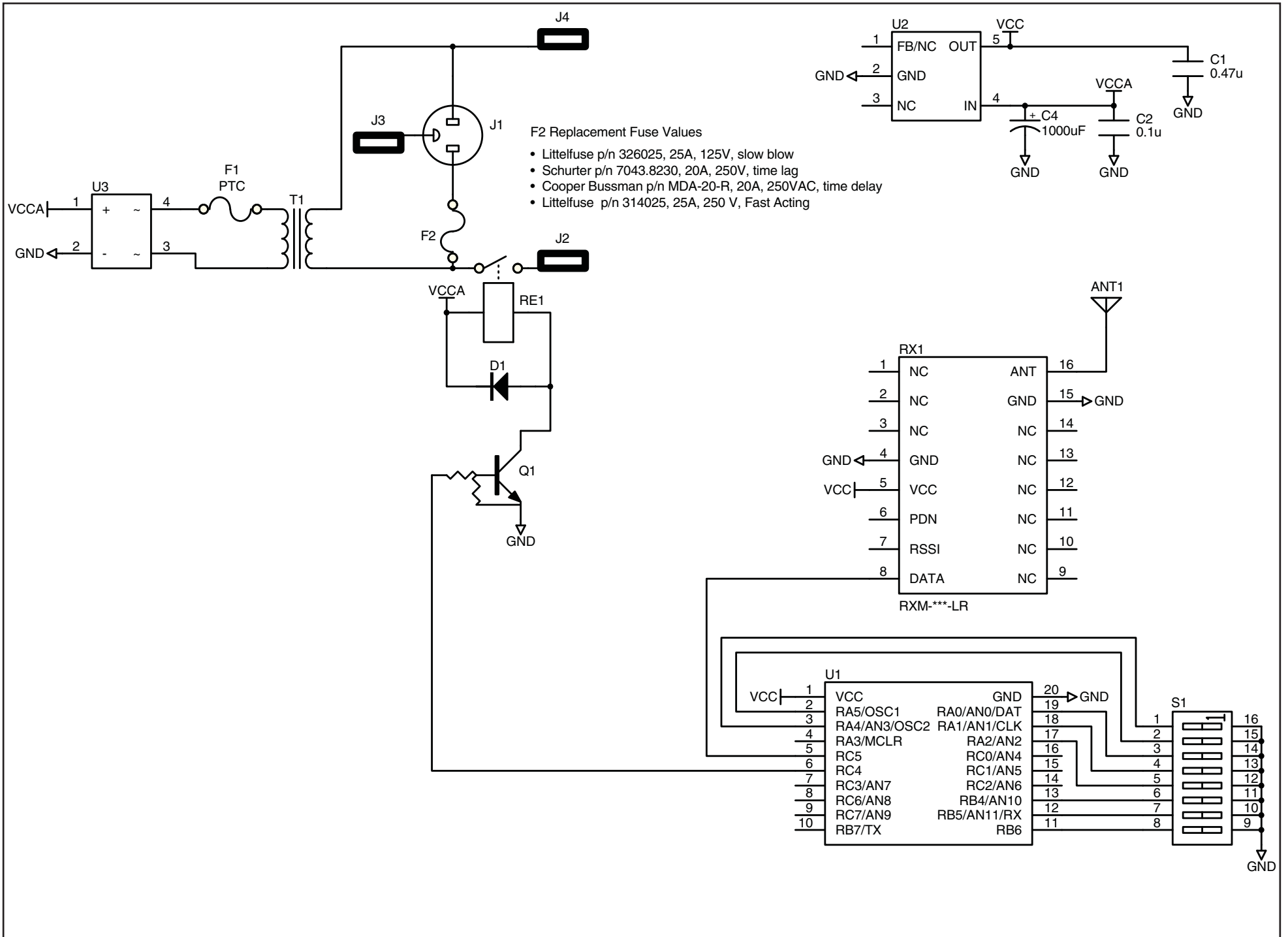

Figure 12: FCTN-WALL-*** Schematic Diagram



U.S. CORPORATE HEADQUARTERS

LINX TECHNOLOGIES

**159 ORT LANE
MERLIN, OR 97532**

**PHONE: (541) 471-6256
FAX: (541) 471-6251
www.linxtechnologies.com**

Disclaimer

Linx Technologies is continually striving to improve the quality and function of its products. For this reason, we reserve the right to make changes to our products without notice. The information contained in this Data Guide is believed to be accurate as of the time of publication. Specifications are based on representative lot samples. Values may vary from lot-to-lot and are not guaranteed. "Typical" parameters can and do vary over lots and application. Linx Technologies makes no guarantee, warranty, or representation regarding the suitability of any product for use in any specific application. It is the customer's responsibility to verify the suitability of the part for the intended application. NO LINX PRODUCT IS INTENDED FOR USE IN ANY APPLICATION WHERE THE SAFETY OF LIFE OR PROPERTY IS AT RISK.

Linx Technologies DISCLAIMS ALL WARRANTIES OF MERCHANTABILITY AND FITNESS FOR A PARTICULAR PURPOSE. IN NO EVENT SHALL LINX TECHNOLOGIES BE LIABLE FOR ANY OF CUSTOMER'S INCIDENTAL OR CONSEQUENTIAL DAMAGES ARISING IN ANY WAY FROM ANY DEFECTIVE OR NON-CONFORMING PRODUCTS OR FOR ANY OTHER BREACH OF CONTRACT BY LINX TECHNOLOGIES. The limitations on Linx Technologies' liability are applicable to any and all claims or theories of recovery asserted by Customer, including, without limitation, breach of contract, breach of warranty, strict liability, or negligence. Customer assumes all liability (including, without limitation, liability for injury to person or property, economic loss, or business interruption) for all claims, including claims from third parties, arising from the use of the Products. The Customer will indemnify, defend, protect, and hold harmless Linx Technologies and its officers, employees, subsidiaries, affiliates, distributors, and representatives from and against all claims, damages, actions, suits, proceedings, demands, assessments, adjustments, costs, and expenses incurred by Linx Technologies as a result of or arising from any Products sold by Linx Technologies to Customer. Under no conditions will Linx Technologies be responsible for losses arising from the use or failure of the device in any application, other than the repair, replacement, or refund limited to the original product purchase price. Devices described in this publication may contain proprietary, patented, or copyrighted techniques, components, or materials. Under no circumstances shall any user be conveyed any license or right to the use or ownership of such items.